

**DESCRIPTION**

- ELECTRONIC BALLAST
- ELECTRONIC TRANSFORMER
- SWITCH MODE POWER SUPPLY

**FEATURES:**

- LOW THERMAL RESISTANCE
- HIGH INPUT RESISTANCE
- FAST SWITCHING
- ROHS COMPLIANT

**MAXIMUM RATINGS (T<sub>c</sub>=25°C)**

PARAMETER	SYMBOL	VALUE	UNIT
Drain-source Voltage	VDS	800	V
gate-source Voltage	VGS	±30	V
Continuous Drain Current (T <sub>C</sub> =25°C)	ID	11	A
Drain Current-Pulsed	IDM	30	A
Total Dissipation	PD	32	W
Junction Temperature	T <sub>j</sub>	150	°C
Storage Temperature	T <sub>stg</sub>	-55-150	°C
Single Pulse Avalanche Energy (I <sub>AS</sub> =11A)	EAS	220	mJ

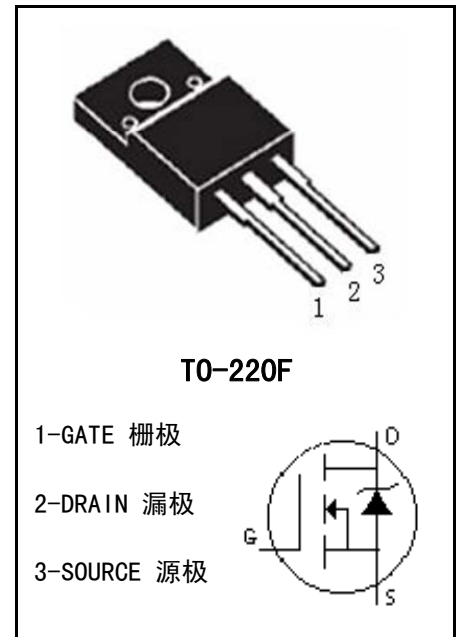
**MECHANICAL**

**ELECTRONIC CHARACTERISTICS (T<sub>c</sub>=25°C)**

CHARACTERISTICS	SYMBOL	TEST CONDITION	MIN	MAX	UNIT
Drain-source Breakdown Voltage	BVDSS	VGS=0V, ID=250uA	800		V
Gate Threshold Voltage	VGS (TH)	VGS=VDS, ID=250 μ A	2.5	4.5	V
Drain-source Leakage Current	IDSS	VDS=800V, VGS=0V		1	uA
Drain-Source Diode Forward Voltage	VSD	VGS=0V, IS=5.5A		1.5	V
Gate-body Leakage Current (VDS = 0)	IGSS	VGS=±30V		±100	nA
Forward Transconductance	gfs	Vds=10V Id=5.5A	0.5		S
Static Drain-source On Resistance	RDS (ON)	VGS=10V, ID=5.5A		0.5	Ω
Thermal Resistance Junction-case	RthJ-c			3.91	°C/W

**■ DYNAMIC CHARACTERISTICS (T<sub>c</sub>=25°C)**

CHARACTERISTICS	SYMBOL	TEST CONDITION	MIN	TYP	MAX	UNIT
Input Capacitance	C <sub>iss</sub>	V <sub>DS</sub> =25V, V <sub>GS</sub> =0V, f=1.0MHZ	-	675	-	pF
output Capacitance	C <sub>oss</sub>		-	235	-	pF
Reverse Transfer Capacitance	C <sub>rss</sub>		-	7	-	pF

**■ SWITCHING CHARACTERISTICS (T<sub>c</sub>=25°C)**

CHARACTERISTICS	SYMBOL	TEST CONDITION	MIN	TYP	MAX	UNIT
Turn-On Delay Time	t <sub>d(on)</sub>	V <sub>DD</sub> =400V, I <sub>D</sub> =5.5A, R <sub>G</sub> =20Ω	-	16	-	ns
Turn-On Rise Time	t <sub>r</sub>		-	12	-	ns
Turn-Off Delay Time	t <sub>d(off)</sub>		-	115	-	ns
Turn-Off Rise Time	t <sub>f</sub>		-	9	-	ns
Total Gate Charge	Q <sub>g</sub>	V <sub>DS</sub> =480V, I <sub>D</sub> =5.5A, V <sub>GS</sub> =10V	-	38	-	nC
Gate-Source Charge	Q <sub>gs</sub>		-	4	-	nC
Gate-Drain Charge	Q <sub>gd</sub>		-	4.2	-	nC

**■ DRAIN-SOURCE DIODE MAXIMUM RATINGS AND CHARACTERISTICS (T<sub>c</sub>=25°C)**

CHARACTERISTICS	SYMBOL	TEST CONDITION	MIN	TYP	MAX	UNIT
Max. Diode Forward Current	I <sub>s</sub>		-	-	11	A
Max. Pulsed Forward Current	I <sub>SM</sub>		-	-	30	A
Diode Forward Voltage	V <sub>SD</sub>	V <sub>GS</sub> =0V, I <sub>S</sub> =5.5A	-	-	1.5	V
Reverse Recovery Time	t <sub>rr</sub>	V <sub>GS</sub> =0V, I <sub>S</sub> =5.5A, dI <sub>F</sub> /dt=100A/μs, V <sub>DD</sub> =100V	-	275	-	ns
Reverse Recovery Charge	Q <sub>rr</sub>		-	3.5	-	μC



CHARACTERISTICS CURVE

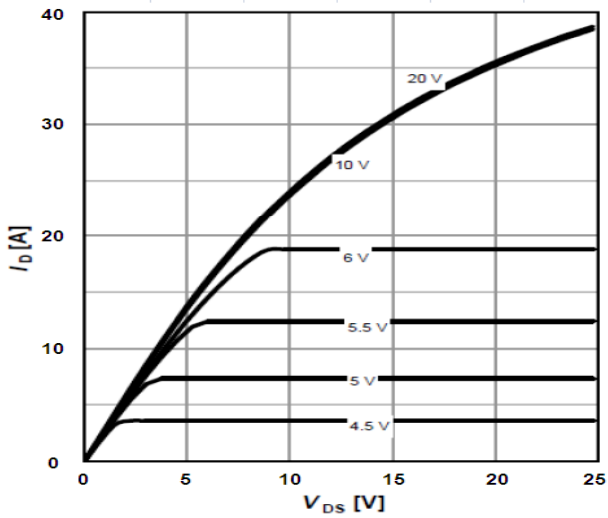

Output Characteristic

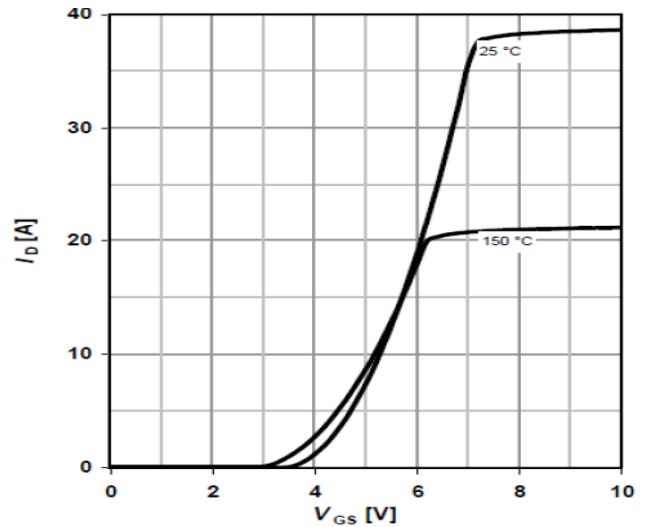

Transfer Characteristic

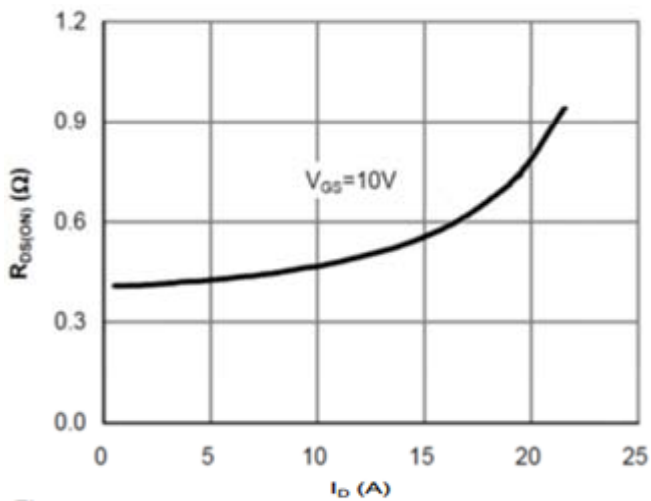

On-Resistance vs. Drain Current and Gate Voltage

On Resistance Vs Drain Current

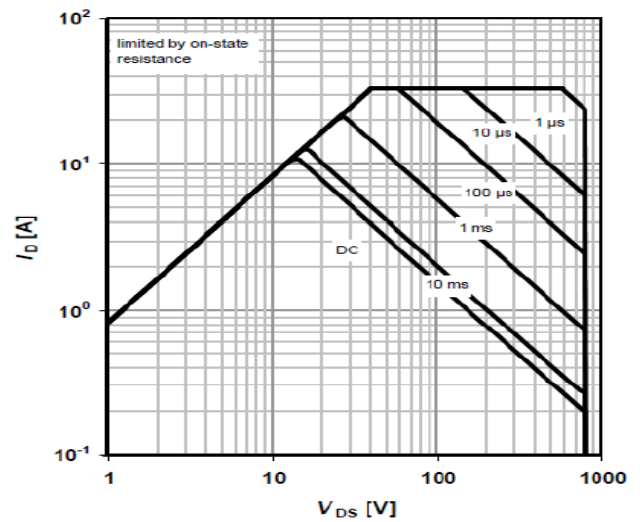

Safe Operating Area

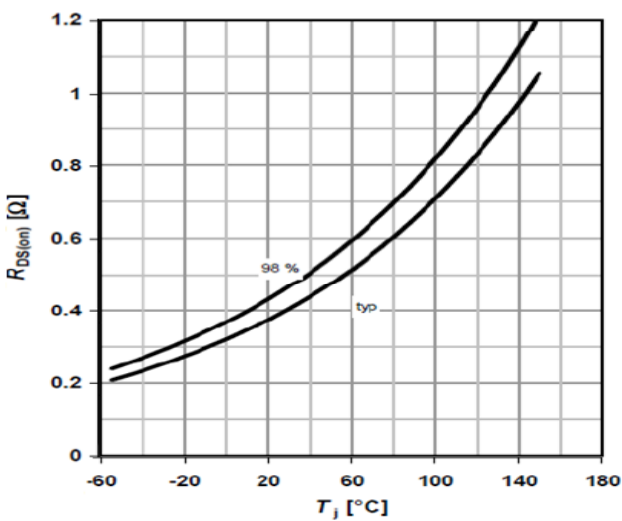

On Resistance Vs Junction Temperature

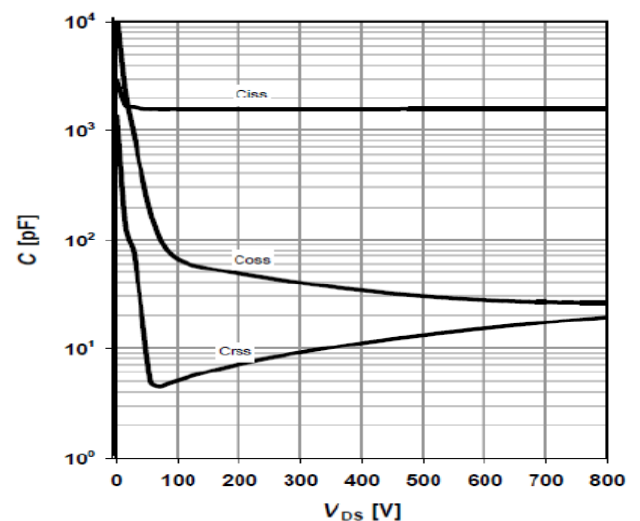

Capacitance



CHARACTERISTICS CURVE

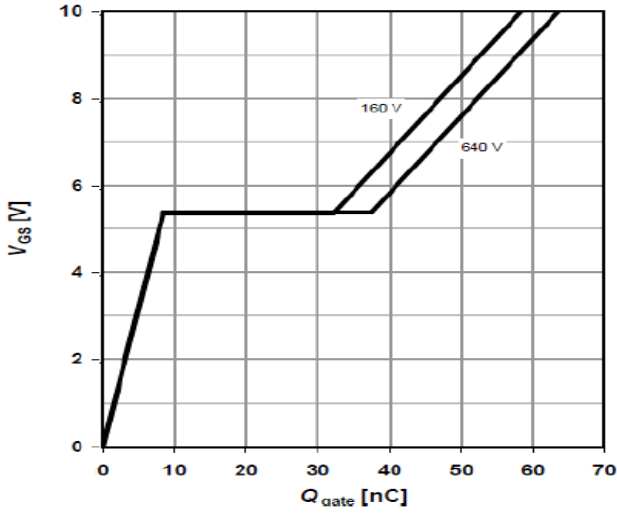

Gate Charge Waveform

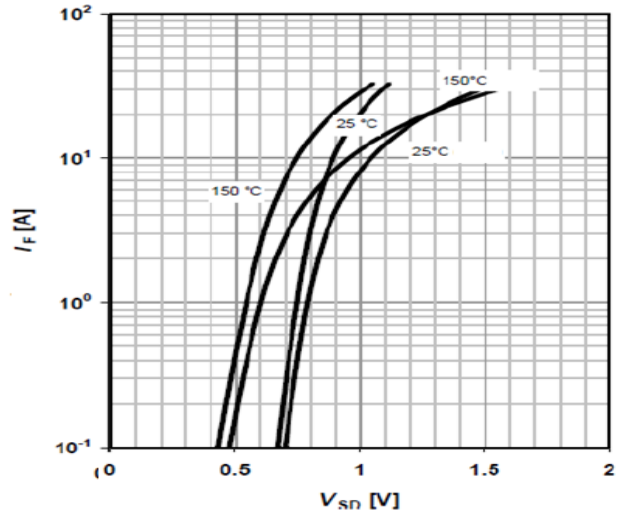

Source-Drain Diode Forward Voltage

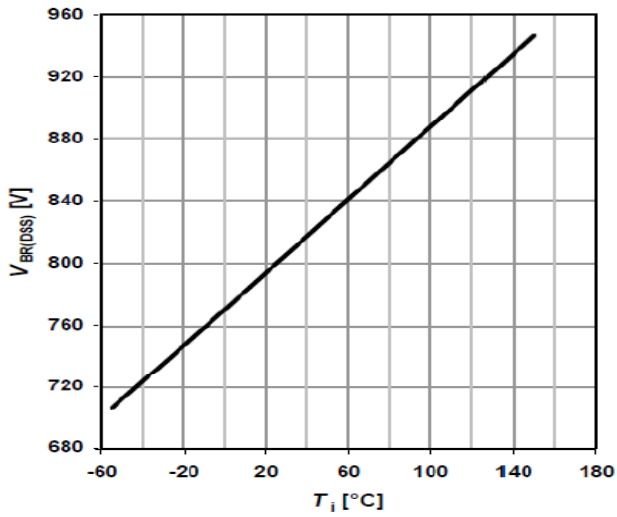

Breakdown Voltage Vs Junction Temperature

**TO-220F MECHANICAL DATA**

UNIT: mm

SYMBOL	MIN	NOM	MAX	SYMBOL	MIN	NOM	MAX
A	4.5		4.9	E1	6.5	7	7.5
A1	2.3		2.9	e	2.44	2.54	2.64
b	0.65		0.9	L	12.5		14.3
b1	1.1		1.7	L1	9.45		10.05
b2	1.2		1.4	L2	15		16
c	0.35		0.65	L3	3.2		4.4
D	14.5		16.5	ΦP	3		3.3
D1	6.1		6.9	Q	2.5		2.9
E	9.6		10.3				

